

Project Name

Fixture Type

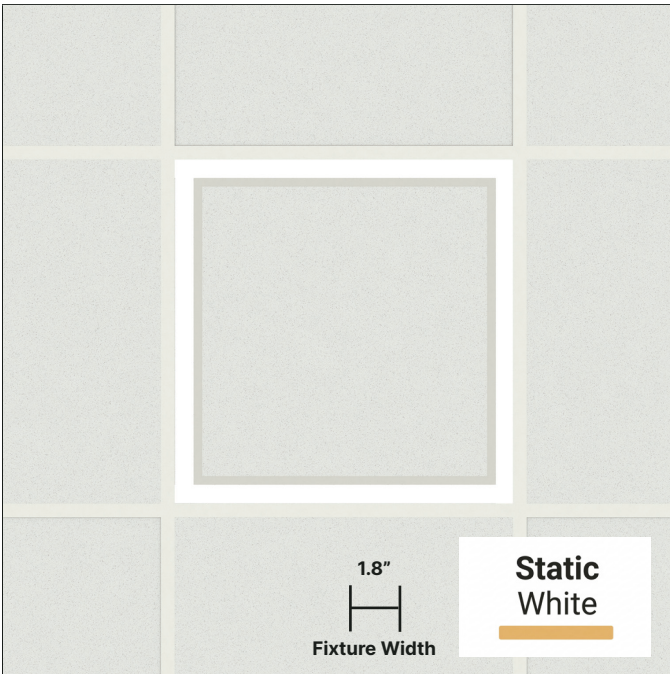

Description

- **Grid Ceiling Integration** – GRIDShape1.5 is approved by Armstrong® Ceiling Systems and seismic tested to ensure reliable integration within suspended grid ceilings.
- **Standard Shapes** – GRIDShape1.5 is an innovative range of pre-fabricated shapes based on the low-profile 1.5" wide GRIDSlot1.5 LED luminaire. Shapes include standard 2X2, 2X4 and 2X8 frames.
- **Low and Zero Plenum Design** – Built specifically for grid ceiling applications, GRIDSlot1.5 offers a zero plenum design that sits flush with the T-bar, enabling clean integration—even in no-plenum conditions.
- **SmartBeam® Optical Control** – Advanced optics deliver high-performance beam distributions tailored to the space.
- **BABAA Compliant** – BABAA & TAA compliant in-house manufacturing in Woburn, MA with North American supply chain.

Key Facts

Dimensions	1.8" (W) X 1.5" (H)
Mounting Style	T-Bar
Standard Lengths	2'X2', 2'X4', & 2'X8'
Finishes	Powder Coated & Anodized
Housing Material	Extruded, Recycled Aluminum
Warranty	5-Year Warranty
Sustainability	Declare Listed & Red List Free
LED Performance	1,000 Lm/Ft, 150 Lm/W efficacy
LED Choices	Static White
Optics Choices	Flush, Regressed, and Micro Baffle
CRI / CCT	80/90/95+, 2700K to 6500K
Driver Options	Factory, Lutron & eldoLED
Emergency Backup	Emergency Circuit & Battery
Compatible Controls	Lutron, Casambi, Cooper, nLight
Power Cord	48"



Project Name

Fixture Type

Fixture Ordering

PRODUCT	FIXTURE LENGTH	FINISH
GSLSH-FL-SW		

GSLSH-FL-SW

1.5" Linear LED Shapes for T-Bar Mount

SQ2X2 - 2'; Square
RT4X2 - 4'x2'; Rectangle
RT8X2 - 8'x2'; Rectangle

Powder Coated
PMW - Matte White
PMB - Matte Black
PMG - Matte Gray
PRAL_ - Specify RAL #

Anodized
ACL - Clear Anodized
ACU_ - Custom Anodized #

CRI	CCT	OPTIC (DIRECT ONLY)	DIRECT BEAM PATTERN	DIRECT OUTPUT

80 - Std. 80 CRI
90 - Std. 90 CRI
95 - High-Def. 95 CRI

27 - 2700K
30 - 3000K
35 - 3500K
40 - 4000K
X_ - Specify CCT

OFL - Flush Lens
ORL - Regressed Lens
OMBW - Micro Baffle, White
OMBB - Micro Baffle, Black

DLAM - Lambertian
DBW60 - Batwing 60°
DDA70 - Double Asym 70°
DA4015 - Asym 40° at 15° Tilt
DA3010 - Asym 30° at 10° Tilt
DM70 - Medium 70°
DN40 - Narrow 40°
X_ - Specify Beam¹

35 - 350 lm/ft
50 - 500 lm/ft
75 - 750 lm/ft
100 - 1,000 lm/ft
X_ - Specify lm/ft

LINE VOLTAGE (DC)	DRIVER LOCATION	DRIVER (POWER)	MOUNTING TYPE

UNV - 120/277V
347 - 347V

FMD - Fixture Mounted Driver
RD - Remote Driver

FDND - Factory Non-Dimming
FD00 - Factory 0-10V 0.1% Dim
FD01 - Factory 0-10V 1% Dim
FD10 - Factory 0-10V 10% Dim
FDDA - Factory DALI 0.1% Dim
FDDX - Factory DMX Dim
FDTR - Factory TRIAC Dim
LD01 - Lutron Hi-Lume 1% Dim
X_ - Specify Driver

Lay-In (Drop-In) Ceiling Tile
TC1 - 9/16" Flat T-Bar + Lay-In Tile Mount
TC3 - 15/16" Flat T-Bar + Lay-In Tile Mount

Optional

EMERGENCY BACKUP	WIRELESS MODULE & SENSOR

EMC - Emergency Circuit
EMB - Emergency Battery (10 W — Remote)
X_ - Specify Backup

WCN - Wireless Communication Node (Connected to LED Driver In-Fixture or In-Driver Box)
PIR - Wireless Communication Node + PIR Sensor (Standard Lens for Low Bay < 10')
MW - Wireless Communication Node + MW Sensor (Standard for Low Bay < 10')
X_ - Other - Specify Embedded Component or Specific Non-Standard Sensor Detection Range

SmartBeam® Technology



The Ultimate Control of Lighting Distributions





















SmartBeam makes it easy to specify the exact light required for any architectural space. Available in every FlexGrid product; it is now possible to create truly tailored and engaging lighting that transform spaces, improves visual comfort, and saves energy.

To learn more about our SmartBeam Technology, please click or scan the QR Code.



Direct Optics Choices

		
Flush Lens	Regressed Lens	Micro Baffle
OFL - Flush Lens	ORL - Regressed Lens	OMBW - White Micro Baffle
		OMBW - Black Nano Baffle

DIRECT OPTICS	BEAM PATTERN						
	DLAM	DBW60	DDA70	DA4015	DA3010	DM70	DN40
Flush Lens							
Regressed Lens							
Micro Baffle							

LPW Efficacy Conversion Chart

CODE	CCT SELECTED							
	2200K	2700K	3000K	3500K	4000K	5000K	5700K	6500K
80	-	0.91	0.96	1.00	1.04	1.11	1.11	1.11
90	-	0.91	0.96	1.00	1.04	1.11	1.11	1.11
95	-	0.91	0.96	1.00	1.04	1.11	1.03	1.04

LPW Performance

	DIRECT						
	DLAM	DBW60	DDA70	DA4015	DA3010	DM70	DN40
LM/W	83	141	123	131	130	149	151

Photometrics

48" Length, 80+/3500K CRI/CCT

Static White Light

DLAM: Lambertian

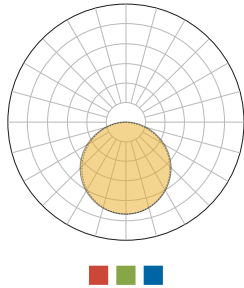

DBW60: Batwing 60°

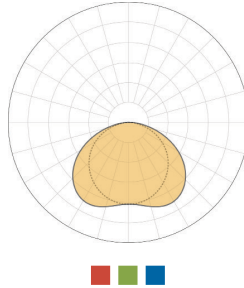

DDA70: Double Asymmetric 70°

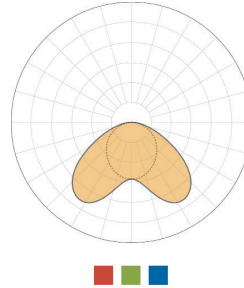

DA4015: Asymmetric 30° at 15° Tilt

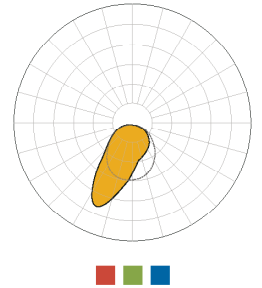

DA3010: Asymmetric 30° at 10° Tilt

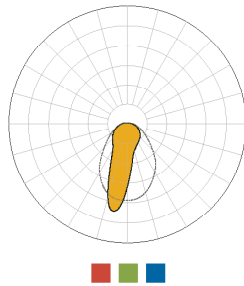

DM70: Medium 70°

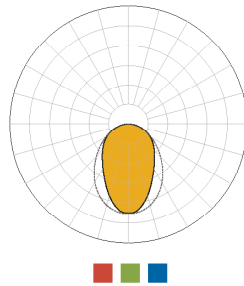

DN40: Narrow 40°

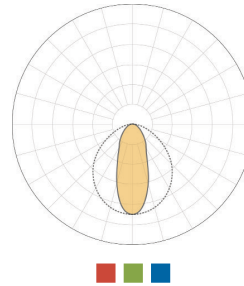

COMPATIBLE OPTIC		
FLUSH LENS	REGRESSED LENS	MICRO BAFFLE
■	■	■

BEAM	OUTPUT							
	350 LPF		500 LPF		750 LPF		1000 LPF	
	W/FT	LM/W	W/FT	LM/W	W/FT	LM/W	W/FT	LM/W
DLAM	4.2	83.3	6	83.3	9	83.3	12	83.3
DBW60	2.5	140	3.5	142.9	5.3	141	7.1	140.1
DDA70	2.8	125	4.1	122	6.1	123	8.1	123.5
DA4015	2.7	129.6	3.8	131.6	5.7	131	7.6	131.6
DA3010	2.8	125	3.9	128.2	5.8	130	7.7	129.9
DM70	2.3	152	3.3	151.5	5	149	6.7	149.3
DN40	2.3	152	3.3	151.5	5	151	6.7	149.3

Dimensions & Installation

Flush Lens and Micro Baffle

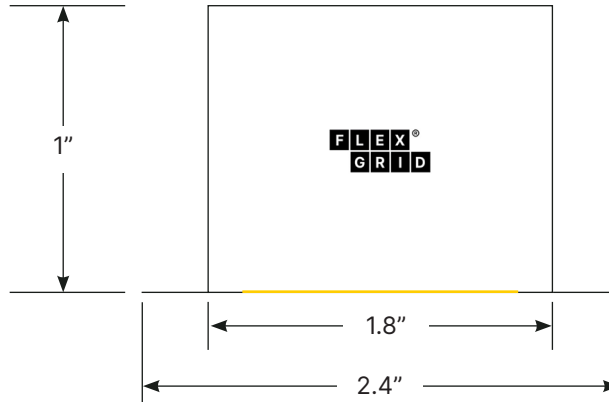
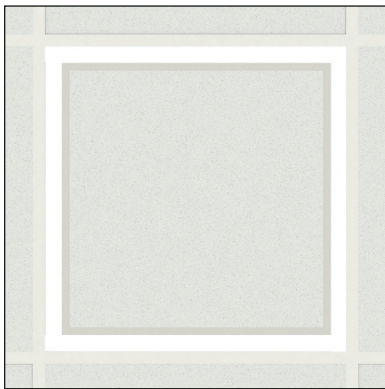

LENGTH	TC1 & TC3	
	STANDARD LENGTHS	ACTUAL LENGTH
SQ2X2 - 2'X2'	2'X2'	23.722"X23.722"
SQ2X2 - 2'X2'	2'X4'	23.722"X47.722"
SQ2X2 - 2'X2'	2'X8'	23.722"X95.722"

Grid Mounting Options

Specifically designed to fit standard T-Bar/Grid Spacing for seamless fit. Available with a range of accessories, mounts and inserts that provide easy customization of visual appearance and performance enhancements.

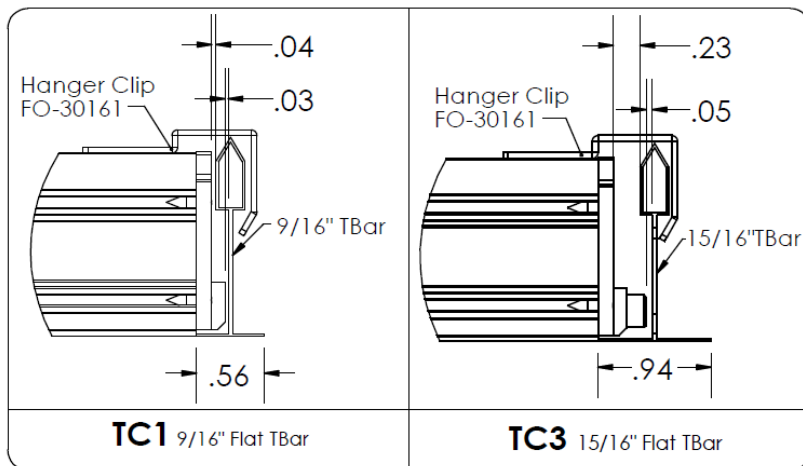

Technical Data

Finishes & Design Options

Housing Colors (Matte Finish)

- White (RAL9003)
- Black (RAL9005)
- Gray (RAL7001)
- Custom RAL

Housing Material

6063-T5 extruded, recycled aluminum

Mounting Brackets and Hardware

Sheet Metal

Flat End Cap Material

Machined or cast aluminum

Lens Options and Material

Flush lens with Patented SmartOptics® made from Acrylic (PMMA).
Micro Baffle options with Polycarbonate.

Standards & Certifications

Sustainability

Low carbon, environmentally conscious packaging and shipping methods

Compliance

BABAA & TAA compliant in-house manufacturing in Woburn, MA with North American supply chain



Certifications



Declare Listed and Red List Free

Low carbon, environmentally conscious packaging and shipping methods

Recyclable

SmartOptics and all powder coated and anodized parts are fully recyclable at end of life

Manufacturing

All FlexGrid products and associated optics and LED engines are assembled at our factory in Woburn, MA

Quality Assurance

Each product is engineered reliability and quality assurance tested

Declare.

Nano Series
XICO Lighting
Final Assembly: Woburn, MA, USA
Life Expectancy: 10+ Years
End of Life Options: Recyclable (99%)

Ingredients:
Aluminum, Glass, acids, chemicals, Poly(methyl methacrylate), Phenol, 4,4'-[1-methyl-4-piperidene]bis-, polymer with 2,2'-(3,3',6,6'-tetrahydrophthalone)bis[4-(4-chlorophenoxy)phenylene]bis[2,6-pyridinediyl], 1,3-benzenedicarboxylic acid, 1,1'-dimethyl ethane polymer with 1,4-dimethyl 1,4-benzenedicarboxylic acid and 1,2-dichloroethane, Polyethylene, Copper, Polyethylene Terephthalate, Barium sulfate, Magnesium, Silicon, Phosphoric acid, phosphoric acid, diphenyl ester from Silicones and Silicones, 8-Mu, Chromium, metallic gold, Manganese, Titanium, Zinc, Nickel, chemicals

Declare Listed

At FlexGrid Lighting, we are committed to transparency and sustainability. That's why all our products are Declare listed, providing clear insights into their environmental footprint and safety. Look for these internationally recognized labels on FlexGrid products, packaging, or at flexgridled.com/declare.



Red List Free

FlexGrid Lighting is dedicated to creating safe, sustainable solutions. All our products are Red List Free, meeting the highest industry standards for healthy and environmentally responsible materials as defined by the International Living Future Institute (ILFI). Learn more at flexgridled.com/declare.

Quick Links

Product Page



SmartBeam



5-YR Warranty

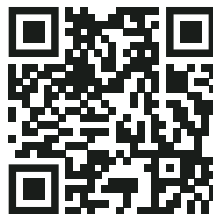

Business Terms

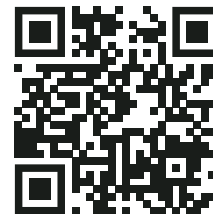

Patents & Trademarks

