

Project Name

Fixture Type

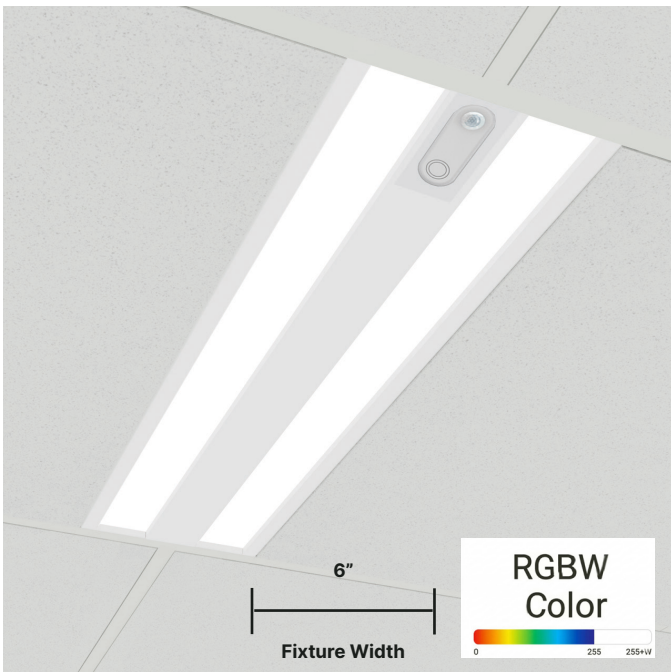

Description

- **Patented T-Bar Replacement** – The only patented linear lighting solution designed to directly replace a T-Bar, GRIDHybrid6 is approved by Armstrong® Ceiling Systems and seismic tested to ensure reliable integration within suspended grid ceilings.
- **Integrated Serviceable Center Section** – Houses a field-serviceable driver, sensors, and controls for simplified maintenance and adaptability.
- **Low and Zero Plenum Design** – Profile sits below the T-Bar main beam, enabling seamless integration in low or no plenum conditions.
- **Flexible Installation** – GRIDHybrid6 can be positioned anywhere in the ceiling grid by mounting directly to a T-bar – in-line or cross-tile.
- **SmartBeam® Optical Control** – Advanced optics deliver high-performance beam distributions tailored to the space.
- **BABAA Compliant** – BABAA & TAA compliant in-house manufacturing in Woburn, MA with North American supply chain.

Key Facts

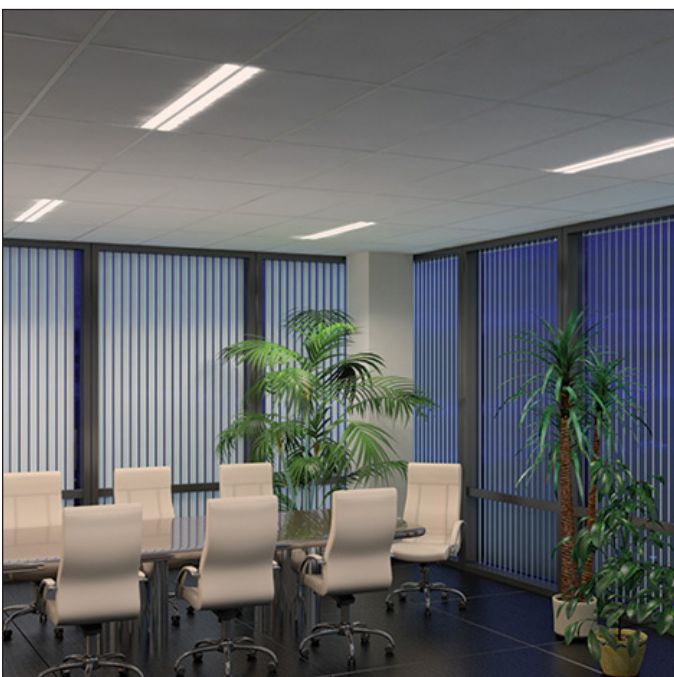

Dimensions	6" (W) X 1.4" (H)
Mounting Style	T-Bar / T-Bar Replacement
Standard Lengths	2FT, 4FT, 6FT, 8FT
Finishes	Powder Coated & Anodized
Housing Material	Extruded, Recycled Aluminum
Warranty	5-Year Warranty
Sustainability	Declare Listed & Red List Free
LED Performance	1,000 Lm/Ft, 135 Lm/W efficacy
LED Choices	RGBW
Optics Choices	Flush & Regressed Lens
CRI / CCT	N/A
Driver Options	Factory DMX
Emergency Backup	Emergency Circuit & Battery
Compatible Controls	Lutron, Casambi, Cooper, nLight
Power Cord	24"



Project Name

Fixture Type

Fixture Ordering

PRODUCT	FIXTURE LENGTH	FINISH
GHY6-FL-RGBW		

GHY6-FL-RG-BW

6" Edge-Lit Linear LED T-Bar Mount

Standard Lengths

- L2** - 2 ft
- L4** - 4 ft
- L6** - 6 ft
- L8** - 8 ft

Custom Lengths

L_X_N_X

L=Feet, N=Inches.

Example: Specifying a 10'3" fixture should be specified as L10N3.

Custom fixtures are only available in 3" increments.

Powder Coated

- PMW** - Matte White
- PMB** - Matte Black
- PMG** - Matte Gray
- PRAL_** - Specify RAL #

Anodized

- ACL** - Clear Anodized
- ACU_** - Custom Anodized #

OPTIC (DIRECT ONLY)	DIRECT BEAM PATTERN	DIRECT OUTPUT	LINE VOLTAGE (DC)

- OFL** - Flush Lens
- ORL** - Regressed Lens

- DLAM** - Lambertian
- DBW65** - Batwing 65°
- DA5025** - Asym 50° at 25°Tilt
- X_** - Specify Beam¹

- 35** - 350 lm/ft
- 50** - 500 lm/ft
- 75** - 750 lm/ft
- 100** - 1,000 lm/ft
- X_** - Specify lm/ft

- UNV** - 120/277V
- 347** - 347V

DRIVER LOCATION	DRIVER (POWER)	MOUNTING TYPE

- ID** - Integral Driver
- RD** - Remote Driver

- FDDX** - Factory DMX Dim
- X_** - Specify Driver

- Lay-In (Drop-In) Ceiling Tile
- TC1** - 9/16" Flat T-Bar + Lay-In Tile Mount
- TC3** - 15/16" Flat T-Bar + Lay-In Tile Mount

Optional

EMERGENCY BACKUP	WIRELESS MODULE & SENSOR

- EMC** - Emergency Circuit
- EMB** - Emergency Battery (10 W — Remote)
- X_** - Specify Backup

- WCN** - Wireless Communication Node (Connected to LED Driver In-Fixture or In-Driver Box)
- PIR** - Wireless Communication Node + PIR Sensor (Standard Lens for Low Bay < 10')
- MW** - Wireless Communication Node + MW Sensor (Standard for Low Bay < 10')
- X_** - Other - Specify Embedded Component or Specific Non-Standard Sensor Detection Range

SmartBeam® Technology

The Ultimate Control of Lighting Distributions

SmartBeam makes it easy to specify the exact light required for any architectural space. Available in every FlexGrid product; it is now possible to create truly tailored and engaging lighting that transform spaces, improves visual comfort, and saves energy.

To learn more about our SmartBeam Technology, please click or scan the QR Code.



Direct Optics Choices



OFL - Flush Lens



ORL - Regressed Lens

DIRECT OPTICS	BEAM PATTERN		
	DLAM	DBW65	DA5025
Flush Lens	■	■	■
Regressed Lens	■	■	■

LPW Efficacy Conversion Chart

CODE	CCT SELECTED							
	2200K	2700K	3000K	3500K	4000K	5000K	5700K	6500K
80	-	0.91	0.96	1.00	1.04	1.11	1.11	1.11
90	-	0.91	0.96	1.00	1.04	1.11	1.11	1.11
95	-	0.91	0.96	1.00	1.04	1.11	1.03	1.04

LPW Performance

	DIRECT		
	DLAM	DBW65	DA5025
LM/W	110	109	141

Photometrics

48" Length, 80+/3500K CRI/CCT



Static White Light

DLAM: Lambertian

DBW65: Batwing 65°

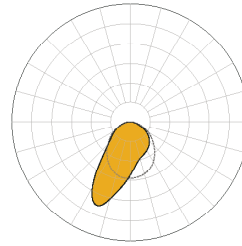
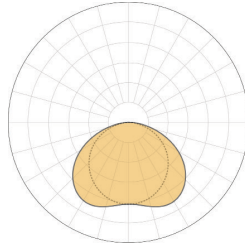
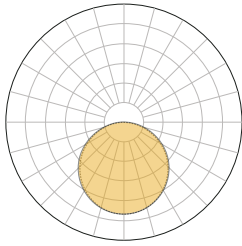
DA5025: Asymmetric 50° at 25° Tilt



COMPATIBLE OPTIC	
FLUSH LENS	REGRESSED LENS
	

BEAM	OUTPUT							
	350 LPF		500 LPF		750 LPF		1000 LPF	
	W/FT	LM/W	W/FT	LM/W	W/FT	LM/W	W/FT	LM/W
DLAM	3.2	109.4	4.5	111.1	6.8	110	9	111.1
DBW60	3.2	109.4	4.6	108.7	6.9	109	9.2	108.7
DA5025	2.5	140	3.5	142.9	5.3	141	7	142.9

Dimensions & Installation

Flush & Regressed Lens

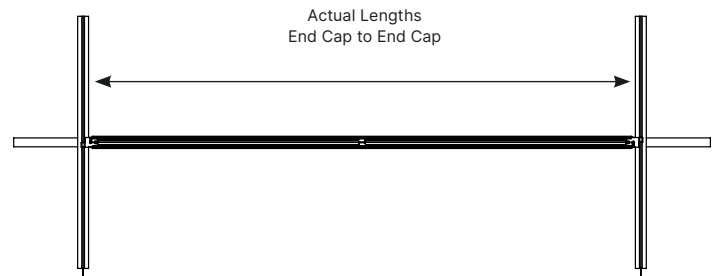
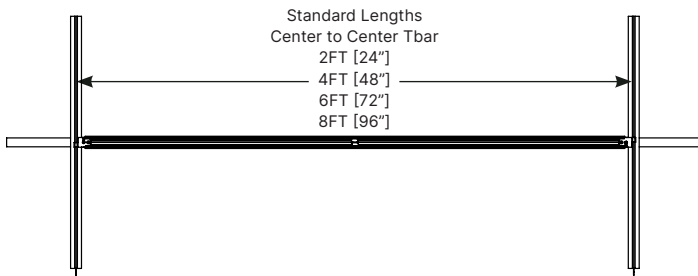
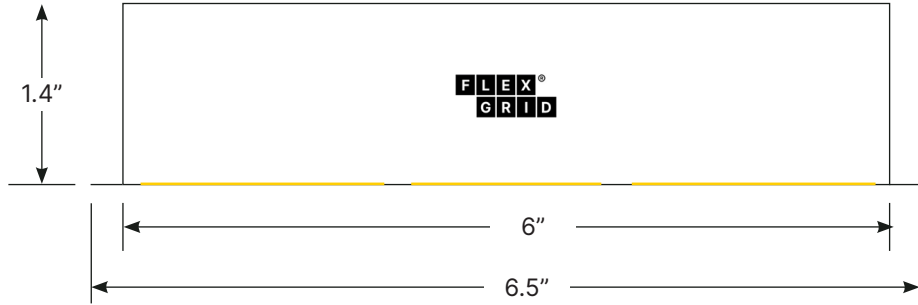

LENGTH	TC1	
	STANDARD LENGTHS	ACTUAL LENGTH
L2 - 2FT	24"	23.91"
L4 - 4FT	48"	47.91"
L6 - 6FT	72"	71.91"
L8 - 8FT	96"	95.91"

LENGTH	TC3	
	STANDARD LENGTHS	ACTUAL LENGTH
L2 - 2FT	24"	23.86"
L4 - 4FT	48"	47.86"
L6 - 6FT	72"	71.86"
L8 - 8FT	96"	95.86"

Grid Mounting Options

Specifically designed to fit standard T-Bar/Grid Spacing for seamless fit. Available with a range of accessories, mounts and inserts that provide easy customization of visual appearance and performance enhancements.

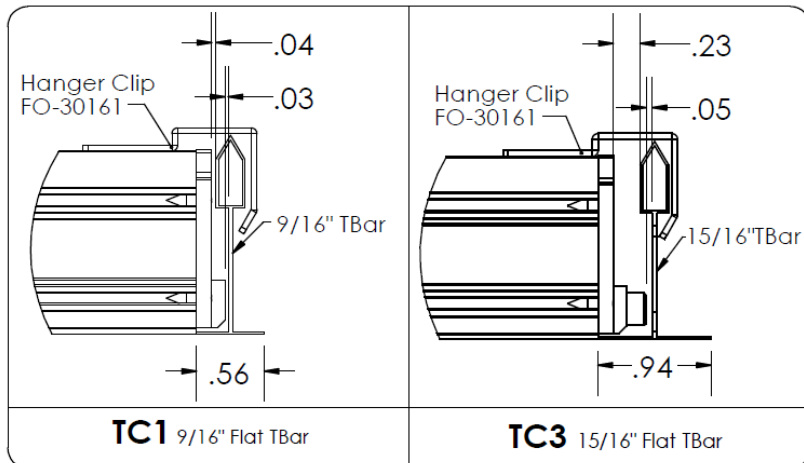

Technical Data

Finishes & Design Options

Housing Colors (Matte Finish)

- White (RAL9003)
- Black (RAL9005)
- Gray (RAL7001)
- Custom RAL

Housing Material

6063-T5 extruded, recycled aluminum

Mounting Brackets and Hardware

Sheet Metal

Flat End Cap Material

Machined or cast aluminum

Lens Options and Material

Flush and Regressed lens with Patented SmartOptics® made from Acrylic (PMMA).

Standards & Certifications

Sustainability

Low carbon, environmentally conscious packaging and shipping methods

Compliance

BABAA & TAA compliant in-house manufacturing in Woburn, MA with North American supply chain



Certifications



Declare Listed and Red List Free

Low carbon, environmentally conscious packaging and shipping methods

Recyclable

SmartOptics and all powder coated and anodized parts are fully recyclable at end of life

Manufacturing

All FlexGrid products and associated optics and LED engines are assembled at our factory in Woburn, MA

Quality Assurance

Each product is engineered reliability and quality assurance tested

Declare.

Nano Series
XICO Lighting
Final Assembly: Woburn, MA, USA
Life Expectancy: 10+ Years
End of Life Options: Recyclable (99%)

Ingredients:
Aluminum, Glass, acids, chemicals, Poly(methyl methacrylate), Phenol, 4,4'-[1-methyl-4-piperidene]bis-, polymer with 2,2'-(3,3',6,6'-tetrahydrophthalone)bis[4-(4-chlorophenoxy)phenyl]propane, 1,3-benzenedicarboxylic acid, 1,1-dimethyl ethyl polymer with 1,4-dimethyl 1,4-benzenedicarboxylate and 1,2-dichloroethane, Polyethylene, Copper, Polyethylene Terephthalate, Barium sulfate, Magnesium, Silicon, Phosphoric acid, phosphoric acid, diphenyl ester, Iron, Silicones and Silicones, 8-Mu, Chromium, metallic, gold, Manganese, Titanium, Zinc, Nickel, chemicals

Declare Listed

At FlexGrid Lighting, we are committed to transparency and sustainability. That's why all our products are Declare listed, providing clear insights into their environmental footprint and safety. Look for these internationally recognized labels on FlexGrid products, packaging, or at flexgridled.com/declare.



Red List Free

FlexGrid Lighting is dedicated to creating safe, sustainable solutions. All our products are Red List Free, meeting the highest industry standards for healthy and environmentally responsible materials as defined by the International Living Future Institute (ILFI). Learn more at flexgridled.com/declare.

Quick Links

Product Page

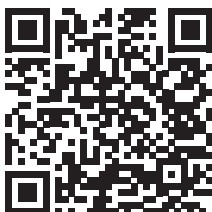

SmartBeam



5-YR Warranty



Business Terms

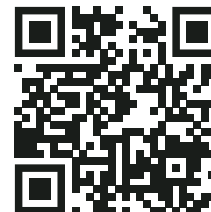

Patents & Trademarks

